

PS2260

PLAYGROUNDS COLLIDE

FINISHED SIZE 72½" x 72½"

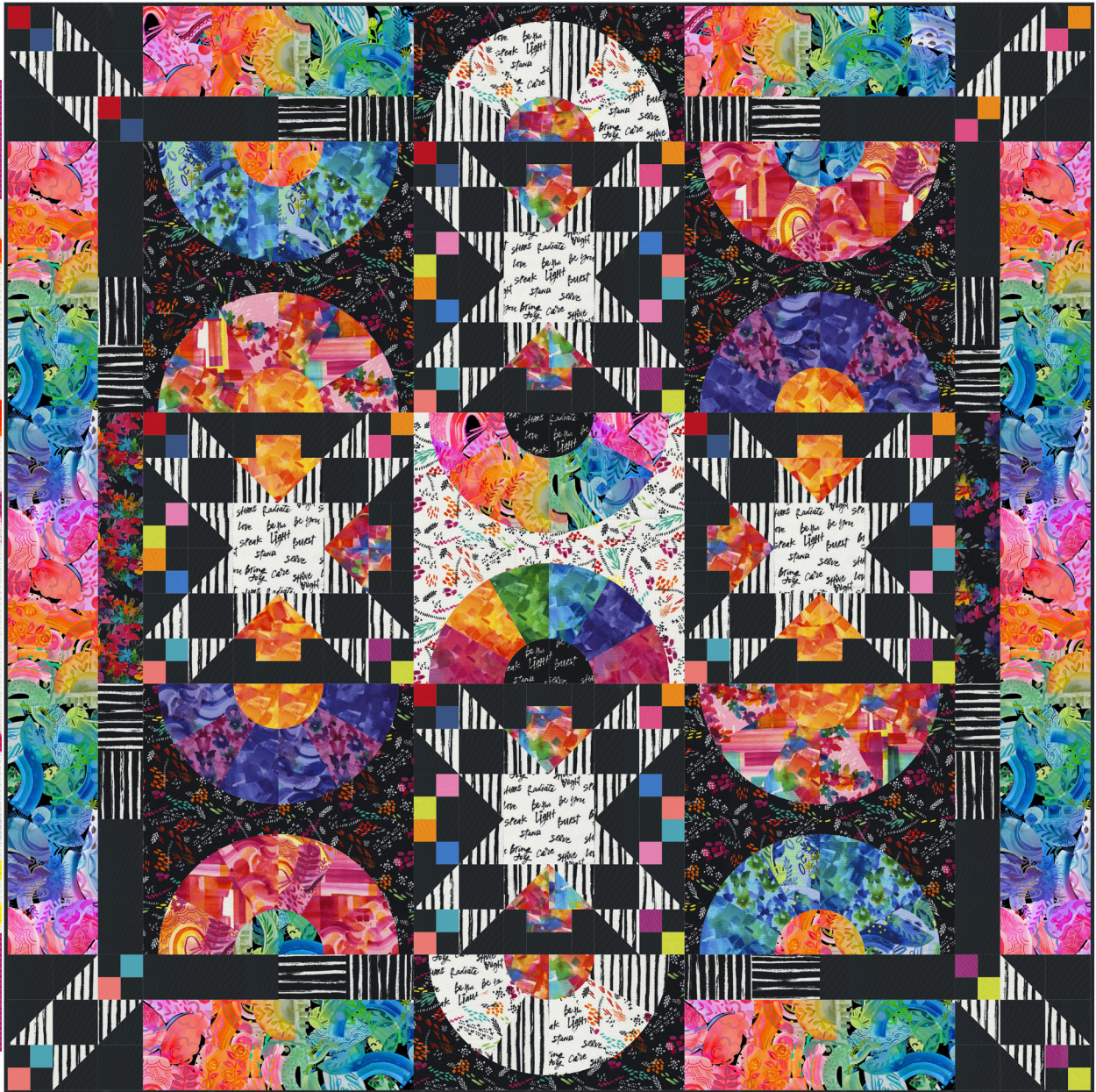

Featuring PLAYGROUNDS by AMARILYS HENDERSON



© 2024 moda fabrics • all rights reserved



CUTTING INSTRUCTIONS

WOF = Width of Fabric (approx. 42")

Before cutting, decide if you are going to piece or applique the rainbow blocks. Your cutting instructions will differ based on the construction method you choose.

For the Rainbow Blocks:

FROM THE RAINBOW ARCH FABRICS:

Cut (1) 6½" x WOF strip and use the B template to cut the number of B wedges indicated:

- (6) wedges from 2270-11
NOTE: Fussy cut wedges to create a rainbow gradient
- (5) wedges each from 2269-15, 2269-16
- (4) wedges each from 2260-11, 2260-13, 2262-11, 2262-13, 2263-11, 2263-12, 2264-11, 2265-11, 2266-11, 2267-11, 2268-12, 2268-13, 2269-17
- (2) wedges from 2269-12
- (1) wedge each from 2269-13, 2269-14

FROM THE RAINBOW CENTER FABRICS:

Cut (1) 4½" x WOF strip and use the C template to cut the number of C quarter-circles indicated:

NOTE: If you are going to applique your rainbows, you can cut half-circles instead of quarter-circles by placing the marked side of the C template on the fold.

- (8) quarter-circles or (4) half-circles each from 2269-13, 2270-11
- (4) quarter-circles or (2) half-circles each from 2266-12, 2269-17

FROM THE RAINBOW BACKGROUND FABRICS:

Cut (1) 10" x WOF strips as indicated and either subcut into 10" squares for appliqueing the rainbows, OR use the A template to cut framing arches for piecing the rainbows.

From 2267-12, cut:

For pieced rainbow blocks:

- (5) 10" x WOF strips, subcut into (20) A templates

For applique rainbow blocks:

- (3) 18½" x WOF strips, subcut into
 - (4) 18½" squares
 - (2) 9½" x 18½" rectangles

From 2267-11, cut:

For pieced rainbow blocks:

- (1) 10" x WOF strips, subcut into (4) A templates

For applique rainbow blocks:

- (1) 18½" x WOF strips, subcut into
 - (1) 18½" square

For the Binding:

FROM 9900-96, cut:

(8) 2½" x WOF strips

For the Star and Corner Blocks:

FROM THE MINI CHARM PACKS:

Select (72) mini charm squares and trim them down to 2" square.

FROM 2265-11, cut:

- (3) 4⅛" x WOF strips, subcut into
 - (20) 4⅛" squares
- (3) 4" x WOF strips, subcut into
 - (24) 4" squares

FROM 2269-13, cut:

- (1) 7½" x WOF strip, subcut into
 - (1) 7½" square
 - (4) 2" x 3½" rectangles

FROM 2269-17, cut:

- (1) 7½" x WOF strip, subcut into
 - (2) 7½" squares
 - (6) 2" x 3½" rectangles

FROM 2266-11, cut:

- (1) 6½" x WOF strip, subcut into
 - (4) 6½" squares

FROM 9900-96, cut:

- (4) 2" x WOF strips, subcut into
 - (72) 2" squares
- (6) 3½" x WOF strips, subcut into
 - (30) 2" x 3½" rectangles
 - (28) 3½" squares
- (3) 4½" x WOF strips, subcut into
 - (24) 4" squares
- (1) 7½" x WOF strip, subcut into
 - (2) 7½" squares

For the Borders:

FROM 2264-14, cut:

- (1) 3½" x WOF strip, subcut into
 - (2) 3½" x 18½" rectangles

FROM 2265-12, cut:

- (1) 3½" x WOF strip, subcut into
 - (6) 3½" x 5" rectangles
- (1) 5" x WOF strip, subcut into
 - (6) 5" x 3½" rectangles

FROM 2270-11, cut:

- (2) 6½" x WOF strips, subcut into
 - (4) 6½" x 18½" rectangles
- (3) 6½" x WOF strips
 - Set aside to piece for length later.

FROM 9900-96, cut:

- (2) 3½" x WOF strips, subcut into
 - (8) 3½" x 9½" rectangles



PIECING INSTRUCTIONS

Refer to pressing arrows throughout pattern.

MAKE THE RAINBOW BLOCKS

NOTE: Refer to the fabric chart below for print groupings and placement.

- Using a scant 1/4" seam, join together (3) B wedges to make a B unit. Press seams open.

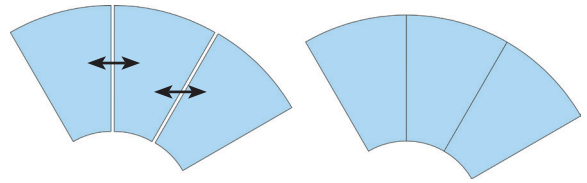

For pieced rainbows (diagrams at right):

- Join a C quarter-circle to a B unit. Press seam to the rainbow wedges.

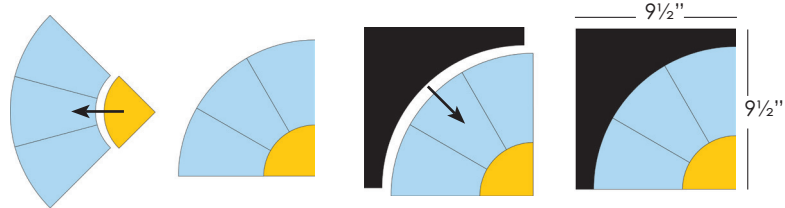

- Join the B/C unit to a background print A unit. Press seam to the rainbow wedges. Trim completed B/C block to 9 1/2" square.

- Matching prints, join (2) B/C blocks to make a half-block measuring 9 1/2" x 18 1/2". Set aside Group 8 Rainbow Half-Blocks for the border.

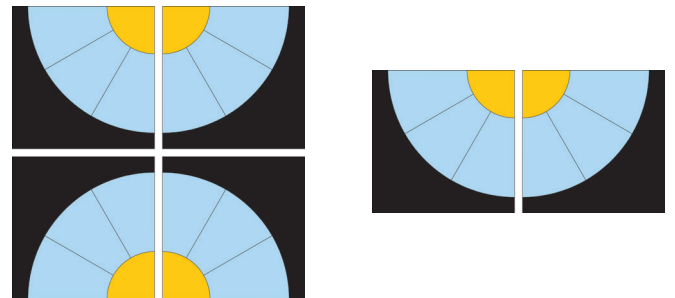

Following the block chart, join (2) half-blocks together as shown to make a full Rainbow Block measuring 18 1/2" square.

For appliqued rainbows (not pictured in diagrams):

- Matching prints, join (2) B units together to make a half-rainbow unit.
- Prepare B units and C half-circles for appliqueing according to your preferred method. Following the block chart, applique half-rainbow units and half-circle units to background squares to make (2) Group 8 Rainbow Half-Blocks measuring 9 1/2" x 18 1/2" and (5) full Rainbow Blocks measuring 18 1/2" square.

NOTE: Refer to the fabric chart below for print groupings and placement.

FABRIC KEY FOR RAINBOW BLOCKS

The fabric key displays eight groups of fabric prints, each with a specific arrangement of block numbers:

- Group 1:** 2269-15, 2268-12, 2260-13, 2270-11. Make 4.
- Group 2:** 2264-11, 2263-12, 2269-17, 2269-13. Make 4.
- Group 3:** 2260-11, 2263-11, 2262-11, 2270-11. Make 4.
- Group 4:** 2262-13, 2268-13, 2269-16, 2269-13. Make 4.
- Group 5A:** 2270-11, 2270-11, 2270-11, 2266-12. Make 1.
- Group 5B:** 2270-11, 2270-11, 2270-11, 2266-12. Make 1.
- Group 6:** 2269-14, 2269-13, 2269-12, 2266-12. Make 1.
- Group 7:** 2269-12, 2269-16, 2269-15, 2266-12. Make 1.
- Group 8:** 2266-11, 2267-11, 2265-11, 2269-17. Make 4.



PIECING INSTRUCTIONS, continued

MAKE FOUR-PATCHES

7. Lay out (2) assorted Bright Bella Solid 2" squares and (2) Black Bella Solid 2" squares as shown. Sew together to make a checkerboard four-patch unit. Press seams to the colorful squares.

Repeat to make (36) four-patch units.
Trim to 3½" square.

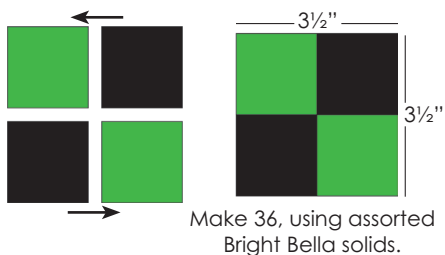

MAKE HSTs

8. Gather (1) 4" striped print (2265-11) square and (1) 4" Black Bella Solid square. On the wrong side of the striped print square, draw a line from one corner to the opposing corner.

Place the print and solid squares right sides together. Stitch a scant ¼" seam on both sides of the drawn line. Cut the square apart on the line to yield two HSTs, and press the seams to the darker triangles.

Repeat to make (48) HSTs. Trim to 3½" square.

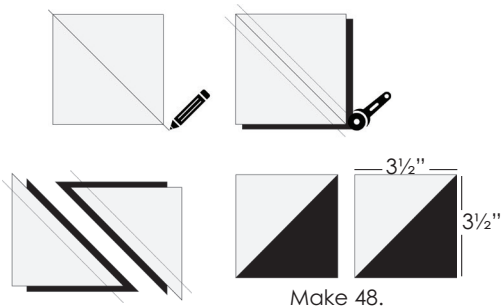

MAKE FLYING GEESE

9. Gather (1) 7½" Black Bella Solid square and (4) 4⅞" striped print (2265-11) squares. On the wrong side of each of the striped print squares, draw a line from one corner to the opposing corner.

Align two striped squares in opposite corners of the larger Black Bella Solid square as shown, right sides together. Stitch a scant ¼" seam on both sides of the drawn line. Cut the square apart on the line to yield two partial flying geese units. Press the seams to the small striped triangles.

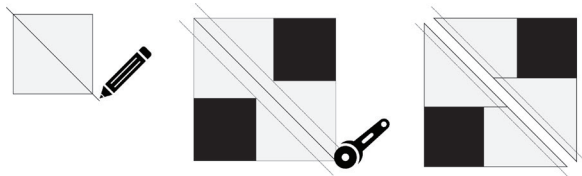

MAKE FLYING GEESE, continued

Align one striped square in the corner of a Black Bella Solid triangle, right sides together. Stitch a scant ¼" seam on both sides of the drawn line. Cut the square apart on the line to yield two complete flying geese units. Press the seams to the small striped triangles.

Repeat this step with the other partial unit to yield the third and fourth complete flying geese units.

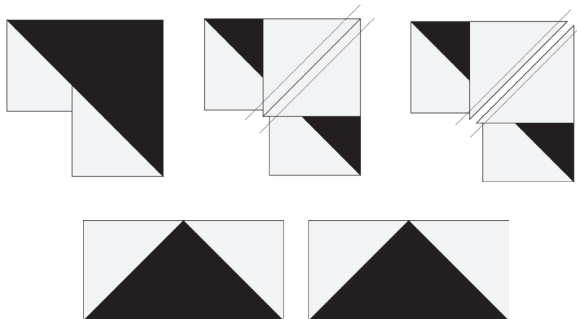

Referring to the fabric pairing diagrams below, repeat Step 9 to make the number of flying geese units indicated.

Trim all flying geese to 3½" x 6½".



ASSEMBLE CORNER BLOCKS

10. Lay out (2) four-patches, (4) HSTs, and (3) 3½" Black Bella Solid squares as shown. Sew together to make a corner block.

Repeat to make (4) corner blocks measuring 9½" square. Set aside for now.

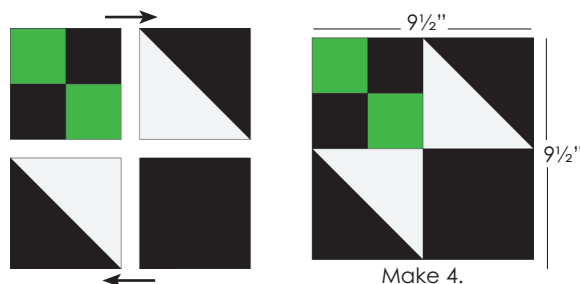



PATTERN TEMPLATES

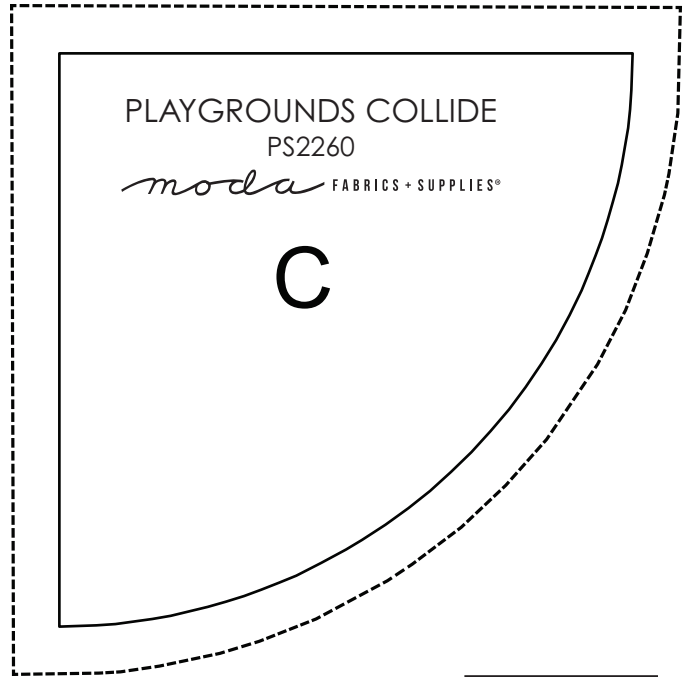
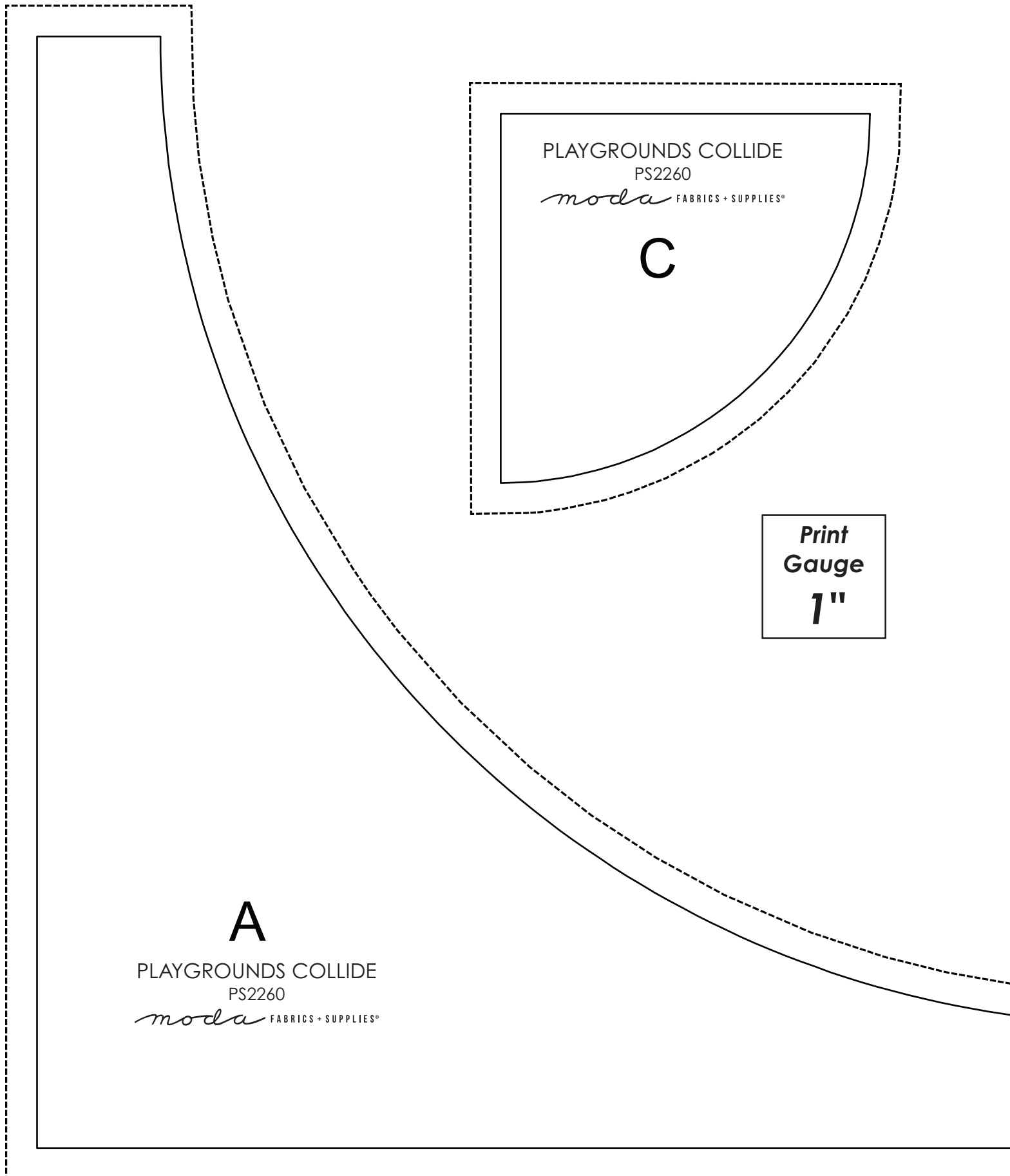

PLAYGROUNDS COLLIDE
PS2260
moda FABRICS + SUPPLIES®

C

**Print
Gauge
1"**

A
PLAYGROUNDS COLLIDE
PS2260
moda FABRICS + SUPPLIES®



PATTERN TEMPLATES

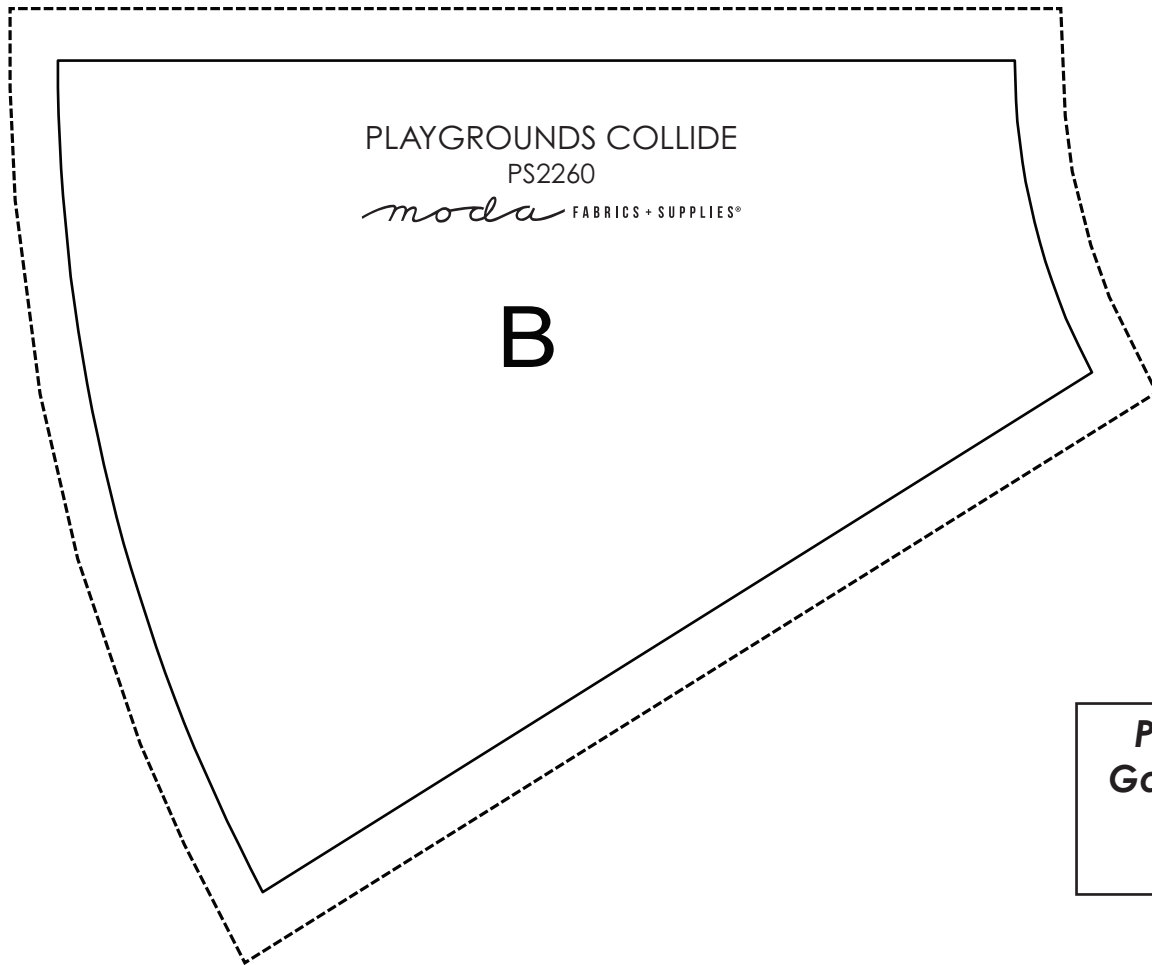

**Print
Gauge
1"**

TEMPLATE TIPS:

Cut out paper templates and use as-is or use to trace onto template plastic for sturdier templates.

Refer to the cutting instructions on page 1 and the fabric key on page 2 to cut the number of shapes required from each listed fabric.

Before cutting, check the print gauge box to confirm that the templates have printed at the correct scale.

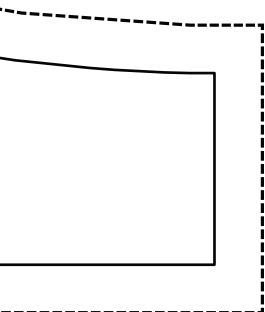



PIECING INSTRUCTIONS, continued

ASSEMBLE STAR BLOCKS

11. Lay out (1) four-patch, (2) HSTs, and (1) 3½" Black Bella Solid square as shown. Sew together to make a corner unit.

Repeat to make (4) corner units. Trim to 6½" square.

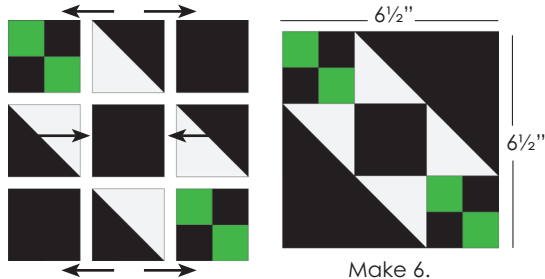

12. Lay out (2) four-patches and (1) Black Bella Solid/striped print flying geese as shown. Sew together to make a solid arrow unit.

Repeat to make (6) solid arrow units.

Trim to 6½" square.

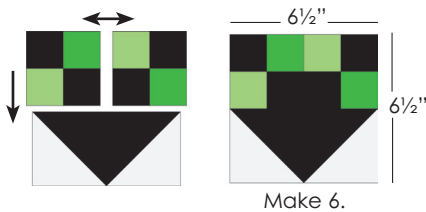

13. Lay out (3) 2" x 3½" Black Bella Solid rectangles and (1) watercolor print 2" x 3½" rectangle as shown. Sew together to make a base unit, pressing seams to the solid rectangles.

Matching prints, sew a base unit to a watercolor print/striped print flying geese as shown to make a print arrow unit. Press seam to the base unit.

Repeat to make (6) multicolor print arrow units and (4) orange-yellow print arrow units. Trim to 6½" square.

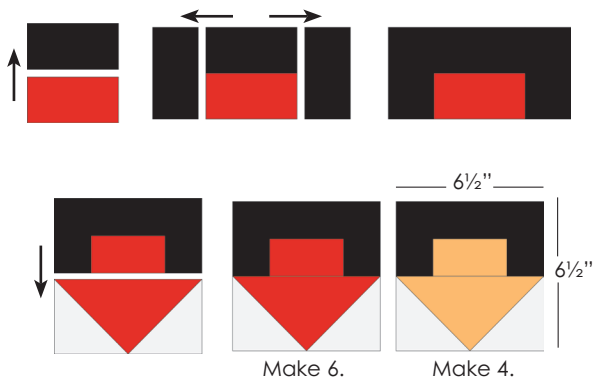

ASSEMBLE STAR BLOCKS, continued

14. Lay out (4) corner units, (2) solid arrow units, (2) multicolor print arrow units, and (1) 6½" text print square as shown. Sew together to make an "A" Star Block.

Repeat to make (2) "A" Star Blocks measuring 18½" square.

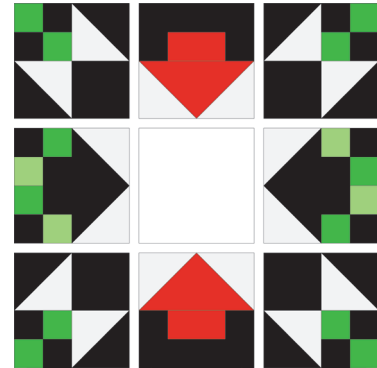

15. Lay out (4) corner units, (2) orange-yellow print arrow units, (1) multicolor print arrow unit, (1) solid arrow unit, and (1) 6½" text print square as shown. Sew together to make a "B" Star Block.

Repeat to make (2) "B" Star Blocks measuring 18½" square.

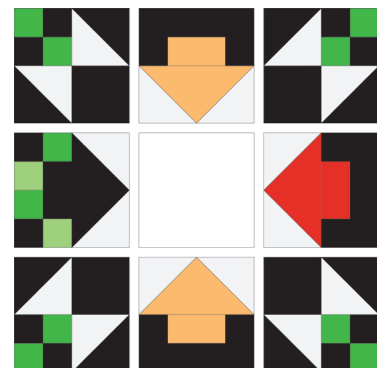



PIECING INSTRUCTIONS, continued

ASSEMBLE BORDER UNITS

16. Lay out (1) $3\frac{1}{2}$ " x $9\frac{1}{2}$ " Black Bella Solid rectangle, (1) $3\frac{1}{2}$ " x 5" striped print (2265-12) rectangle, and (1) 5" x $3\frac{1}{2}$ " striped print (2265-12) rectangle as shown, paying attention to the orientation of the stripes in the print rectangles. Sew together to make a left border strip measuring $3\frac{1}{2}$ " x $18\frac{1}{2}$ ".

Repeat to make (4) left border strips.

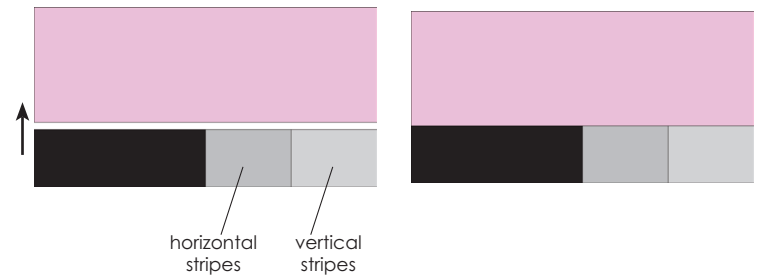

17. Join (1) $6\frac{1}{2}$ " x $18\frac{1}{2}$ " rainbow print (2270-11) rectangle to the top of a left border strip as shown to make an A Border unit.

Repeat to make (2) A Border units measuring $9\frac{1}{2}$ " x $18\frac{1}{2}$ ".

18. Lay out (1) 5" x $3\frac{1}{2}$ " striped print (2265-12) rectangle, (1) $3\frac{1}{2}$ " x 5" striped print (2265-12) rectangle, and (1) $3\frac{1}{2}$ " x $9\frac{1}{2}$ " Black Bella Solid rectangle as shown, paying attention to the orientation of the stripes in the print rectangles. Sew together to make a right border strip measuring $3\frac{1}{2}$ " x $18\frac{1}{2}$ ".

Repeat to make (4) right border strips.

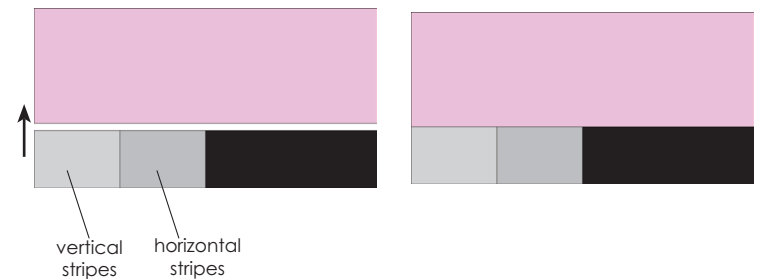

19. Join (1) $6\frac{1}{2}$ " x $18\frac{1}{2}$ " rainbow print (2270-11) rectangle to the top of a right border strip as shown to make a B Border unit.

Repeat to make (2) B Border units measuring $9\frac{1}{2}$ " x $18\frac{1}{2}$ ".

20. Lay out (1) left border strip, (1) $3\frac{1}{2}$ " x $18\frac{1}{2}$ " rainbow butterfly print (2264-14) rectangle, and (1) right border strip as shown. Sew together to make a side border strip measuring $3\frac{1}{2}$ " x $54\frac{1}{2}$ ".

Repeat to make (2) side border strips.



21. Join the (3) $6\frac{1}{2}$ " x WOF rainbow print (2270-11) strips end to end to make one long strip.

From that strip, cut (2) $54\frac{1}{2}$ " pieces.

Join a side border strip to a $6\frac{1}{2}$ " x $54\frac{1}{2}$ " rainbow print strip as shown to make a C Border unit.

Repeat to make (2) C Border units measuring $9\frac{1}{2}$ " x $54\frac{1}{2}$ ".



22. Lay out (2) Corner Blocks, an A Border unit, a Group 8 Half-Rainbow Block, and a B Border unit as shown. Sew together to make the top border measuring $9\frac{1}{2}$ " x $72\frac{1}{2}$ ".

Repeat to make the bottom border.





ASSEMBLY AND FINISHING INSTRUCTIONS

ASSEMBLE QUILT

22. Lay out Rainbow Blocks and Star Blocks as shown. Sew together to make the quilt center measuring $54\frac{1}{2}$ " x $54\frac{1}{2}$ ".
Sew a C Border unit to the left and right sides of the quilt center. The top should measure $54\frac{1}{2}$ " x $72\frac{1}{2}$ " at this point.
24. Sew the top and bottom borders to the quilt top. The finished quilt top should measure $72\frac{1}{2}$ " x $72\frac{1}{2}$ ".
25. Baste, quilt, and bind as desired.

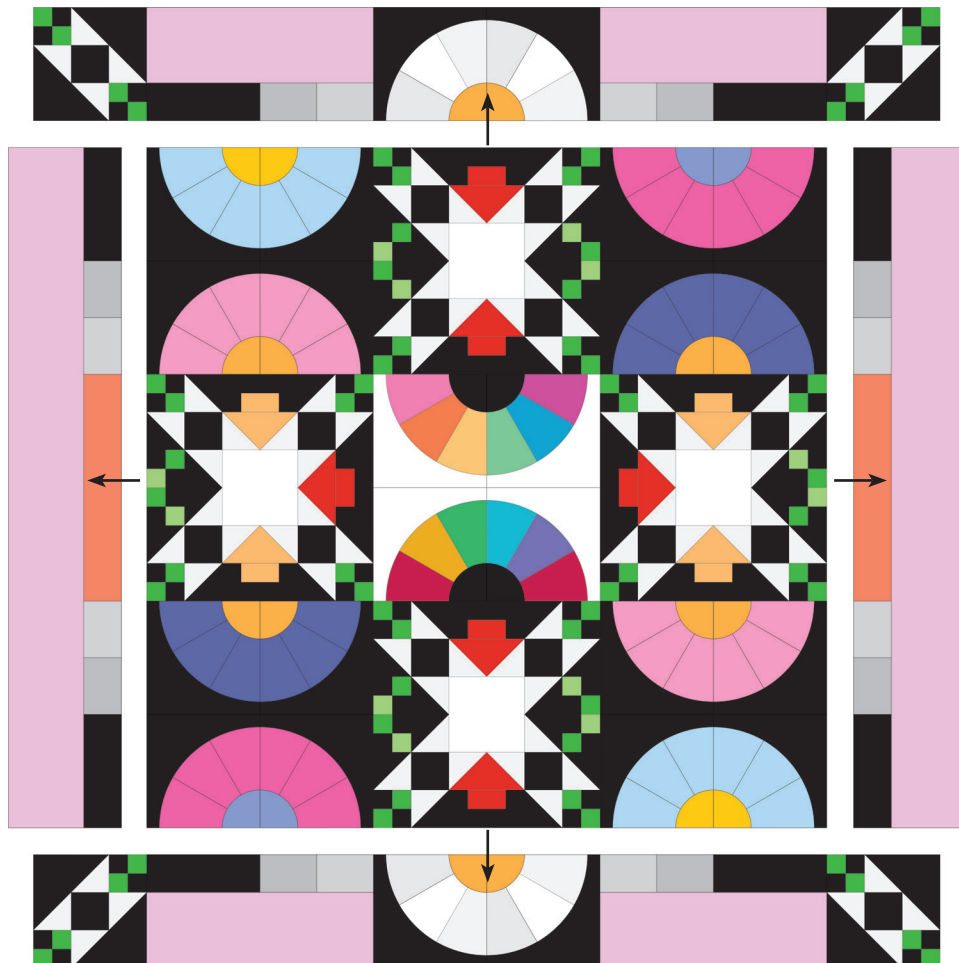
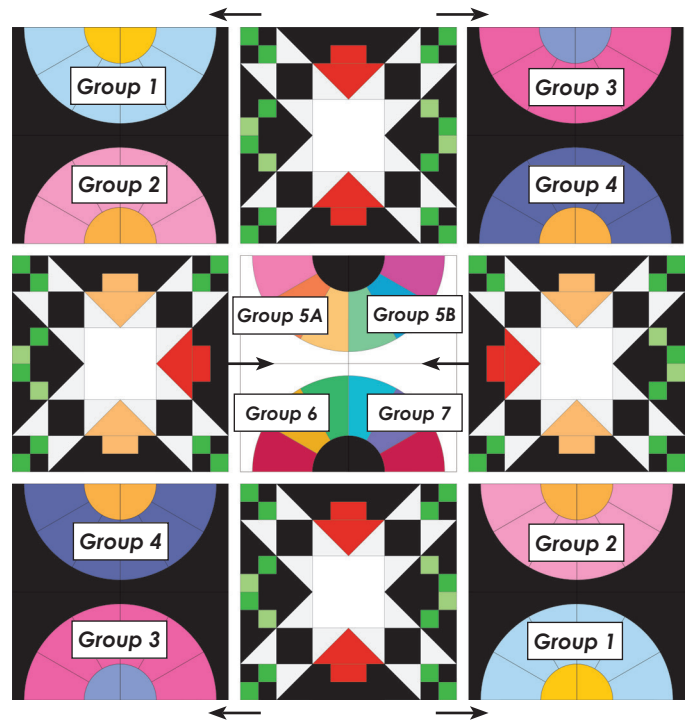

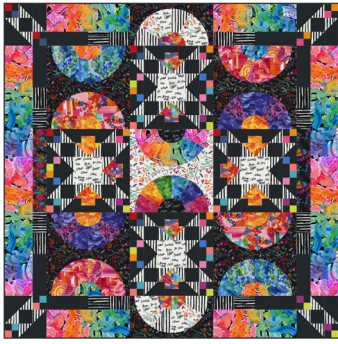

moda PLAYGROUNDS COLLIDE

FINISHED SIZE 72½" x 72½"

Featuring PLAYGROUNDS by AMARILYS HENDERSON

© 2024 moda fabrics • all rights reserved

FABRIC REQUIREMENTS

⅛ YARD, EACH:



2264-14

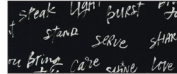

2266-12

¼ YARD, EACH:



2260-11



2260-13



2262-11



2262-13



2263-11

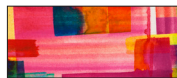

2263-12



2264-11



2265-12



2268-12



2268-13



2269-12



2269-14



2269-15



2269-16

⅜ YARD, EACH:

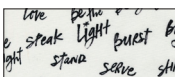

2266-11



2269-13

2 MODA BRIGHT BELLA SOLIDS
MINI CHARM PACKS



9900MCB

½ YARD:



2267-11

⅝ YARD:



2269-17

⅞ YARD:



2265-11

1⅓ YARDS:

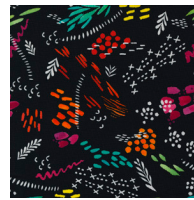

2267-12

2 YARDS:



2270-11

2¼ YARDS:



9900-96
(includes binding)

4½ YARDS:

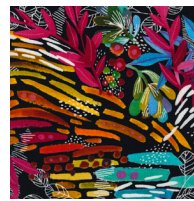

2261-13

(backing)