

Dream Big

by Sherri McConnell of A Quilting Life

It's always exciting to start a new year with a new list of projects. This block contains several different units and lots of options for playing with your fabric placement. The possibilities are inspiring. Have fun sewing, and Happy New Year!

@aquiltinglife

aquiltinglife.com

youtube.com/aquiltinglife

Cutting Instructions

Qty	6" finished block	12" finished block
8	1 1/2" squares (A)	2 1/2" squares (A)
4	2" squares (B)	3" squares (B)
4	2" squares (C)	3" squares (C)
1	3 1/2" square (D)	5 1/2" square (D)
4	2 1/8" squares (E)	3 1/8" squares (E)
1	3 1/2" square (F)	5 1/2" square (F)
4	2 1/8" squares (G)	3 1/8" squares (G)
1	2 1/2" square (H)	4 1/2" square (H)
4	1 1/2" squares (I)	2 1/2" squares (I)

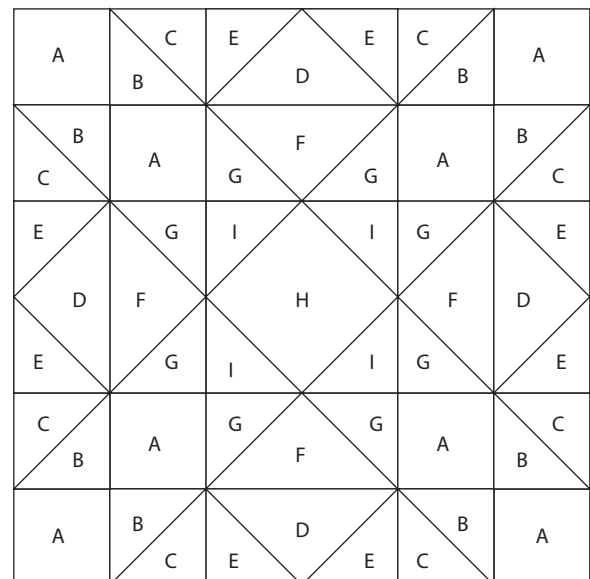

Use this block to plan color and fabric placement!

My Swatches

A B C D E F

G H I





SCAN ME

Piecing Instructions

Step 1

On the wrong side of each B square, draw a line from one corner to the opposing corner as shown.

Place B and C squares right sides together. Stitch a scant $\frac{1}{4}$ " seam on both sides of the drawn line. Cut the square apart on the line to yield two HSTs, and press the seams to the darker triangles (B).

Repeat to make 8 B/C HSTs. Trim HSTs to $1\frac{1}{2}$ " (6" block) or $2\frac{1}{2}$ " (12" block).

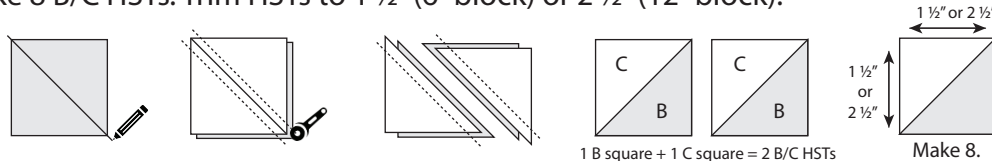

Step 2

Lay out 2 A squares and 2 B/C HSTs as shown. Sew together to make an A/B/C corner unit.

Repeat to make 4 corner units measuring $2\frac{1}{2}$ " (6" block) or $4\frac{1}{2}$ " (12" block).

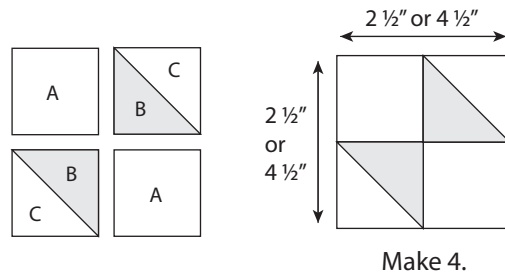

Step 3

On the wrong side of each E square, draw a line from one corner to the opposing corner as shown.

With right sides together, align 2 E squares in opposite corners of the D square as shown.

Stitch a scant $\frac{1}{4}$ " seam on both sides of the drawn line.

Cut the square apart on the line to yield 2 partial flying geese units, and press the seams to the E triangles.

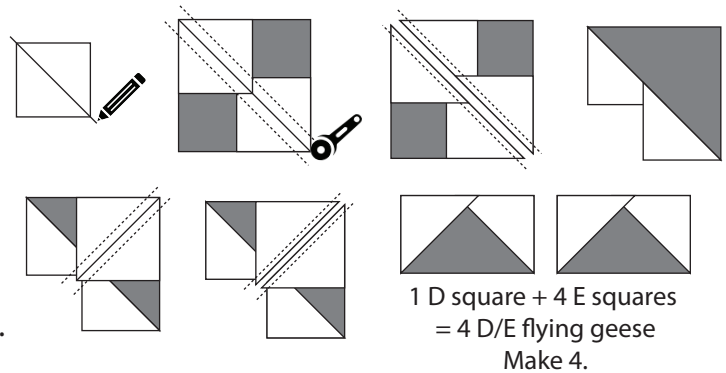

With right sides together, align another E square in the corner of the D triangle as shown.

Stitch a scant $\frac{1}{4}$ " seam on both sides of the drawn line. Cut the square apart on the line to yield 2 complete flying geese units, and press the seams to the E triangles.

Repeat to make 4 D/E flying geese units. Trim to $1\frac{1}{2}$ " x $2\frac{1}{2}$ " (6" block) or $2\frac{1}{2}$ " x $4\frac{1}{2}$ " (12" block).

Get to know Sherri...

I thank my lucky stars that...
I accepted my grandmother's offer to teach me to quilt.

Star Trek, Star Wars, or Dancing With the Stars?
Definitely Star Wars!





Piecing Instructions, continued

Step 4

Using the F and G squares, repeat Step 3 make 4 F/G flying geese units. Trim to 1 1/2" x 2 1/2" (6" block) or 2 1/2" x 4 1/2" (12" block).

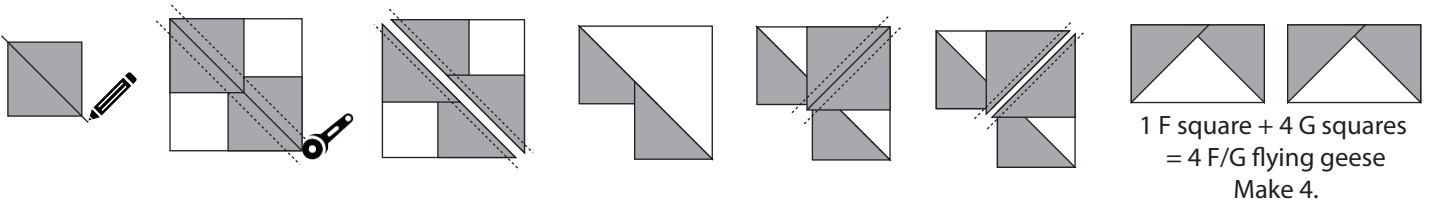

Step 5

Lay out 1 D/E flying geese and 1 F/G flying geese as shown. Sew together to make a flying geese unit. Press seam open.

Repeat to make 4 flying geese units measuring 2 1/2" (6" block) or 4 1/2" (12" block).

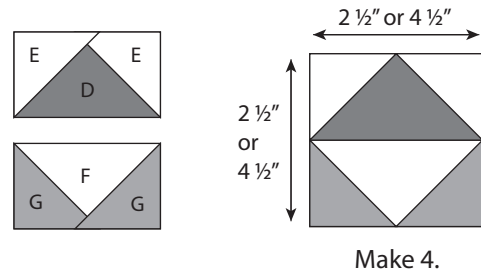

Step 6

On the wrong side of each I square, draw a line from one corner to the opposing corner as shown.

Place an I square on the top left corner of the H square,

right sides together. Stitch on the drawn line, and trim the seam to 1/4". Press the seam towards the triangle (I).

Repeat stitch-and-flip steps on remaining H square corners as shown to create a square-in-a-square unit measuring 2 1/2" (6" block) or 4 1/2" (12" block).

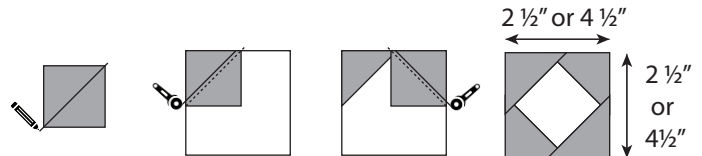

Step 7

Lay out corner units, flying geese units, and square-in-a-square unit as shown.

Join units to make the full block.

Trim to 6 1/2" or 12 1/2".

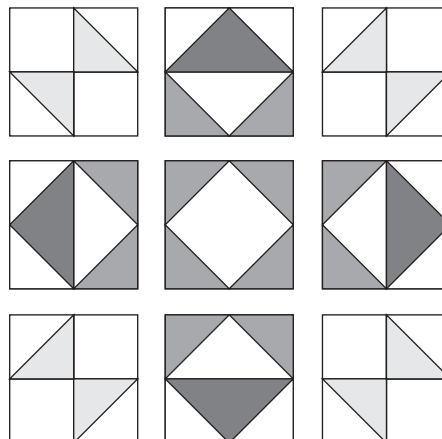



Additional Coloring Blocks

